

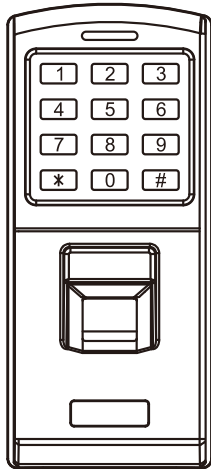

S4A Industrial Co., Limited

Fingerprint Access Control System User Manual



I. Product Overview and Installation Instruction

Applicable Models

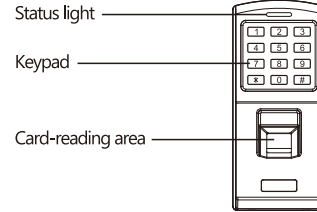

S.N.	Functions
1	Dark-background fingerprint reader
2	User verification with fingerprint or card
3	Tamper alarm
4	Reading head for data output

- Operating Environment is as follows.
- Room temperature: -20°C- +50°C
- Relative humidity: 95%
- Operating Voltage & Current as follows.
- Input DC: +12V
- Standby current: ≤60mA
- Operating current: ≤120mA

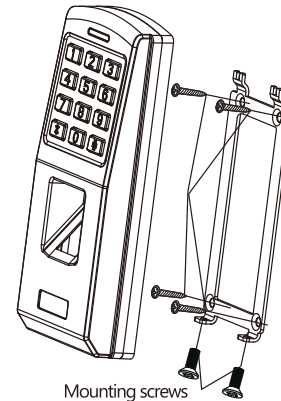

Due to continuous update of our products

II. Inputting Fingerprint

Suggested finger: index finger, middle finger or ring finger instead of thumb or little finger

1) Correct method

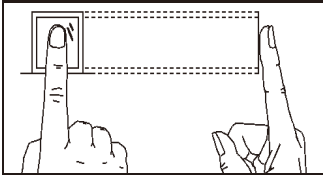

Use the finger to evenly press the center of fingerprint are

2) Wrong methods

Incomplete touch

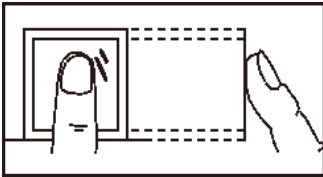

Off center

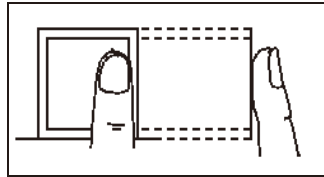

Turn sideways

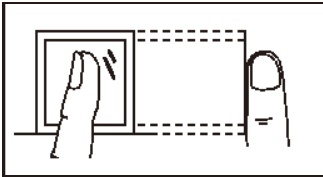

Low position

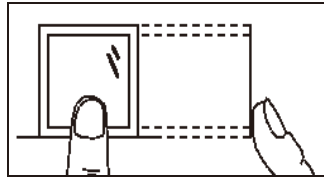

Please input fingerprint correctly for verification, and improper operation might result in poor performance of this device

III. Ports & Wiring Diagram

Connect this device and breaker via NO, COM and NC output to separate from internal circuit of this device.

Once relay gets closed, electric lock is released.

Contact output current:3A;

Connection diagram:

please refer to right diagram.

Relay Output Connection Diagram

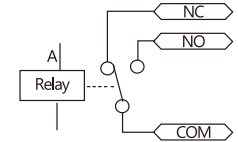

High level output in case of alarm Alarm Port

Connection Diagram

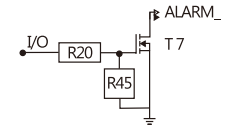

Wiring Diagram

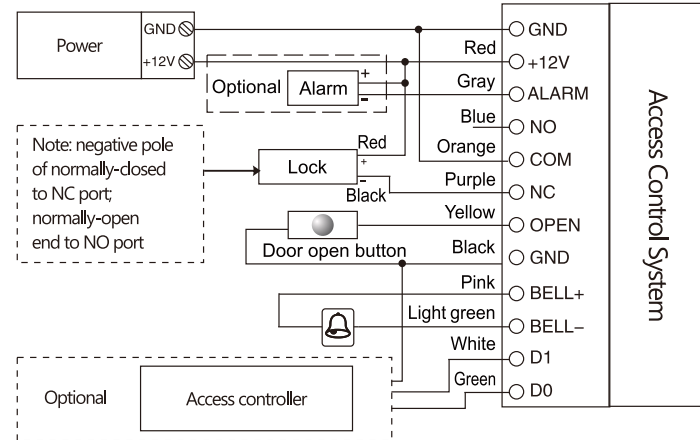

IV. Administrator Operation

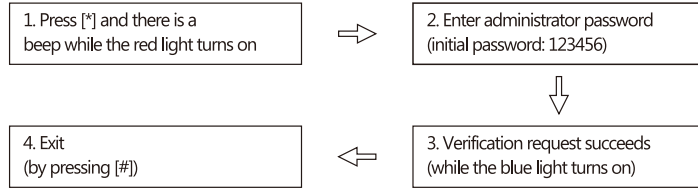

Remarks:

After successful verification, user is allowed to register Administrator account. Then the initial password will be invalid.

4.1 Registering Administrator

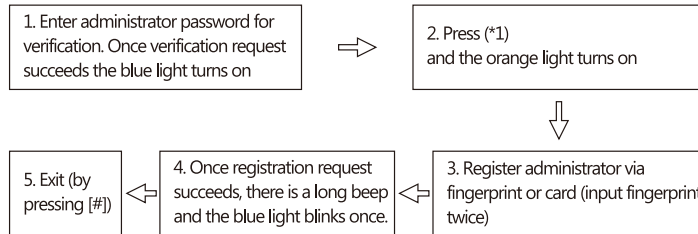

Remarks:

1. It is allowed to register with 5 administrator only via fingerprint or card.
2. In case administrator quantity reaches the maximum value, the newly-enrolled admins will be cleared according to the serial number.

4.2 If the administrator password is lost.

Power off, press #, hold it, and power on, after 5 seconds, there will be one long beep, means delete the master successfully, then release the button

Attention: Do not release the # button until one long beep

V. To enroll a new user

5.1 A new users ID will be generated automatically.

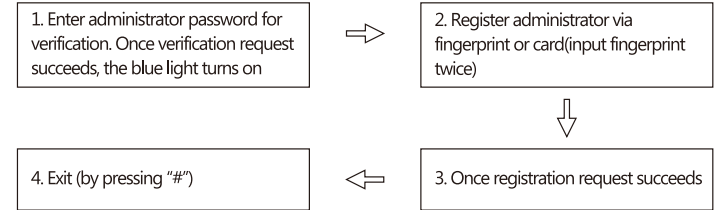

5.2 Register users by inputting the Employee ID directly.

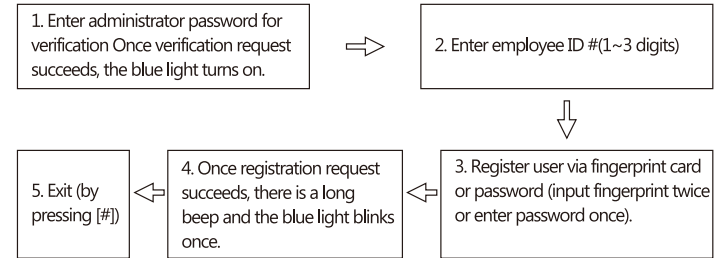

VI: Verification

6.1 User Verification via Fingerprint

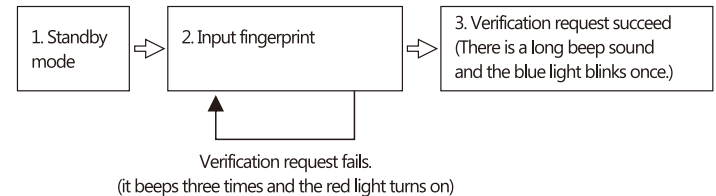

6.2 User Verification via Password

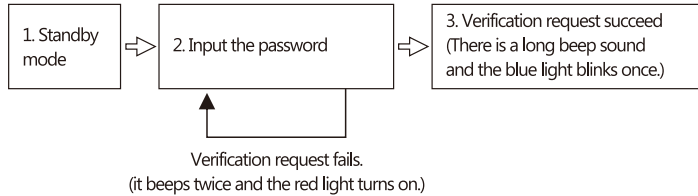

VII: Deleting Users

7.1 Delete a User

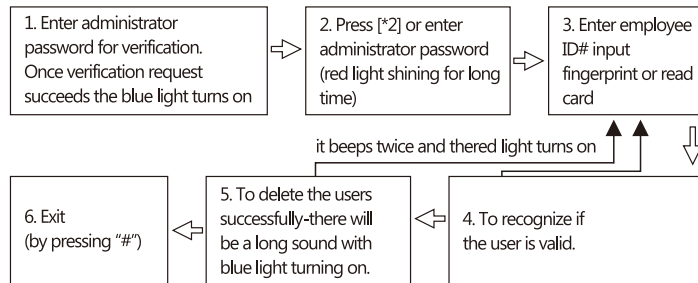

7.2 Delete All Users

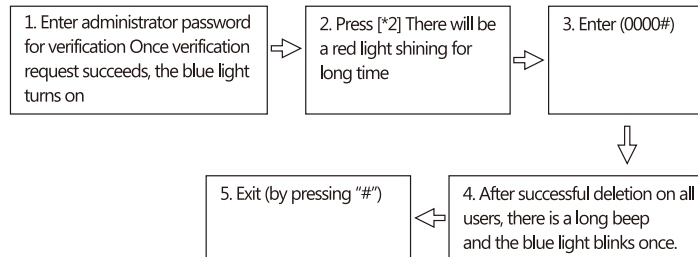

VIII: Access Control System Management

8.1 System Settings

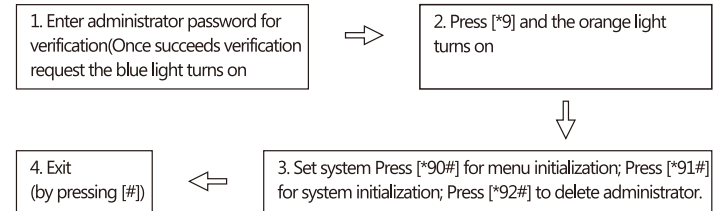

8.2 Setup the time for unlocking.

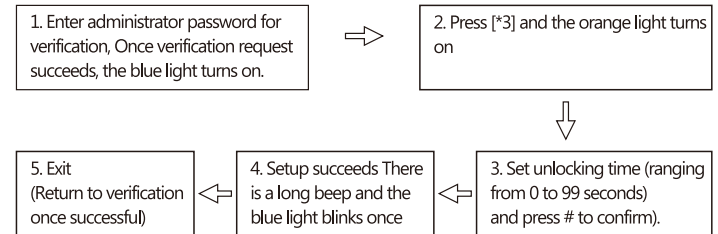

IX: Unpacking

Description	Specifications	Quantity	Remarks
Device		1	
Packaging box		1	
Plastic plugs	Φ 4mmX28mm	4	For mounting and fixing
Self-tapping screws	Φ 4mmX28mm	4	For mounting and fixing